

pannelli scorrevoli - porte

 **Hema**

catalogo 05

sliding doors - doors

Abitare è un linguaggio. Gli spazi di vita raccontano molto di noi, dei nostri desideri delle nostre abitudini. Racchiuse da preziose e sobrie cornici che delimitano gli ambienti in maniera discreta ed avvolgente, le porte Tema non sanno passare inosservate. Dotate di grande personalità sanno essere forti e delicate allo stesso tempo, solide ma anche raffinate. Porte che catturano e trattengono gli sguardi, protagoniste indiscusse dei vostri spazi di vita o di lavoro. Soluzioni perfette per chi ama vivere comodamente circondato da cose belle.

The language of design. A living space can tell you much about ourselves, our desires, our habits. The cool clear lines of Temadoors define spaces discreetly without fuss creating a strong but refined framework for your living or working space. The perfect answer for people who want to live in comfort surrounded by beautiful things.



*range of TEMA internal doors
in a private residence
Angeli Roberto - RICCIONE (RN)*

*realizzazioni con porte d'arredo TEMA
in abitazione privata
Angeli Roberto - RICCIONE (RN)*



45

90

45. taglio cornici a 45°
frame 45°

90. taglio cornici a 90°
frame 90°

PORTA A BATTENTE
HINGED DOOR

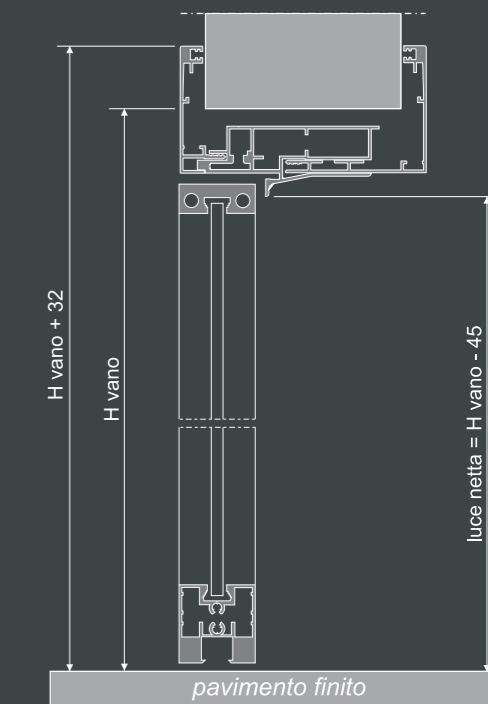
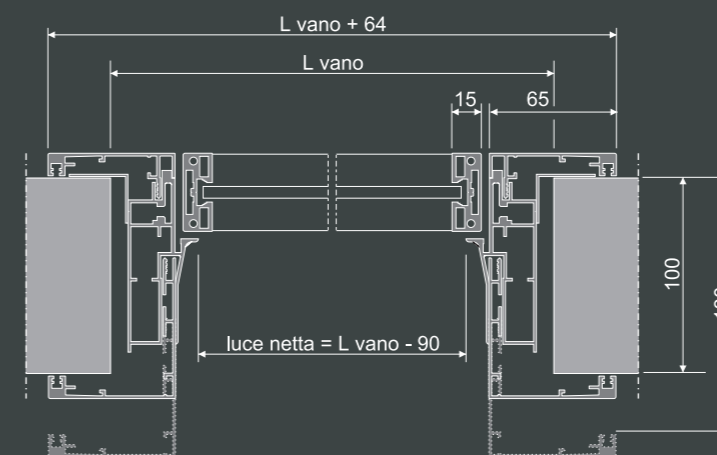

PORTA SCORREVOLE A SCOMPARS
SLIDING DOOR FOR POCKET SYSTEM

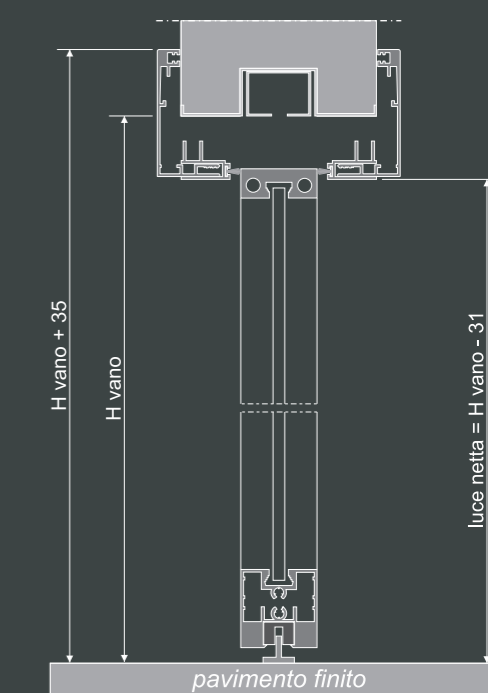
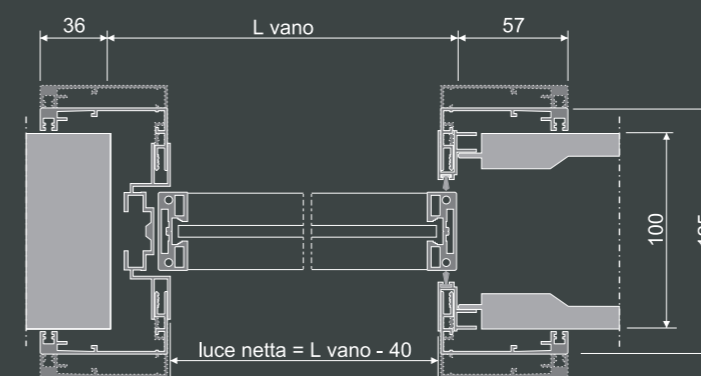



maniglia "clip" argento lucido
 handle "clip" polished silver finish



PLAN15 E/RS/NC

quattro pannelli scorrevoli in alluminio/vetro
 a raso soffitto con binario incassato
vetro stratificato satinato nero
alluminio argento lucido
maniglia "clip" argento lucido

four sliding aluminum/glass doors flush to the ceiling
glass laminated satin black
aluminium polished silver finish
handle "clip" polished silver finish

**PLAN15 E/RS/NC**

quattro pannelli scorrevoli
in alluminio/vetro a raso
soffitto con binario incassato
vetro temprato trasparente
alluminio nero
maniglia "clip" nero

*four sliding aluminum/glass
doors flush to the ceiling
glass tempered clear
aluminium black finish
handle "clip" black finish*

**PLAN40 B/SF**

doppio pannello scorrevole
in alluminio/vetro a
soffitto con veletta in vista
vetro temprato satinato bianco
alluminio argento opaco
maniglia "dado" argento opaco

*double sliding aluminum/glass
doors ceiling mounted with fascia
glass tempered satin white
aluminium matt silver finish
handle "dado" matt silver finish*

maniglia "olivari total" biocromo satinato con chiusura magnetica su adattatore orizzontale
handle "olivari total" biochrome satin finish and horizontal adaptor with magnetic lock, black finish



PLAN BT-1

porta a battente con anta alluminio/vetro e stipite in alluminio
vetro temprato satinato bianco
alluminio bianco avorio
maniglia "HCS 1880" con riporto bianco avorio su adattatore HCS

hinged aluminum/glass door with aluminum frame
glass tempered satin white
aluminium ivory finish
handle "HCS 1880" and HCS adaptor ivory finish

maniglia "HCS 1880" con riporto bianco avorio su adattatore HCS
handle "HCS 1880" and HCS adaptor ivory finish

maniglia "olivari planet Q" cromo opaco con chiusura magnetica su adattatore rettangolare argento opaco
handle "olivari planet Q" matt chrome finish and rectangular adaptor with magnetic lock, matt silver finish

PLAN BT-1

porta a battente con anta alluminio/vetro e stipite in alluminio
vetro temprato satinato bianco
alluminio argento opaco
maniglia "HCS A197" argento opaco su adattatore HCS argento opaco

hinged aluminum/glass door with aluminum frame
glass tempered satin white
aluminium matt silver finish
handle "HCS A197" and HCS adaptor matt silver finish



maniglia "jazz" cromo opaco
handle "jazz" matt chrome finish



PLAN BT-2

porta a doppio battente con
anta alluminio/vetro
e stipite in alluminio
vetro temprato satinato bianco
alluminio bianco avorio
maniglia "jazz" cromo opaco

*double hinged aluminum/glass
doors with aluminum frame
glass tempered satin white
aluminium ivory finish
handle "jazz" matt chrome finish*



PLAN BT-1

porta a battente con anta alluminio/vetro
e stipite in alluminio
vetro temprato trasparente
alluminio nichel
maniglia "olivari tecno" nichel con
serratura magnetica su adattatore
rettangolare nichel

*hinged aluminum/glass door
with aluminum frame
glass tempered clear
aluminium nickel finish
handle "olivari Tecno" and rectangular
adaptor with magnetic lock, nickel finish*



PLAN15 SC-1

porta scorrevole a scomparsa con anta
in alluminio/vetro e stipite in alluminio
vetro stratificato opalino
alluminio argento opaco
maniglia "clip" argento opaco

*sliding aluminum/glass door for pocket
system with aluminum frame
glass laminated opal
aluminium matt silver finish
handle "clip" matt silver finish*



PLAN15 SC-2

doppia porta scorrevole a scomparsa con ante in alluminio/vetro e stipite in alluminio
vetro stratificato nero
alluminio argento opaco
maniglia "clip" argento opaco

double sliding aluminum/glass doors for pocket system with aluminum frame
glass laminated black
aluminium matt silver finish
handle "clip" matt silver finish



PLAN15 SC-1-CIRCULAR

porta scorrevole a scomparsa curva con ante in alluminio/vetro e stipite in alluminio
vetro temprato satinato bianco
alluminio argento opaco
maniglia "dado" argento opaco

circular sliding aluminum/glass door for pocket system with aluminum frame
glass tempered satin white
aluminium matt silver finish
handle "dado" matt silver finish

maniglia "dado" bianco avorio
handle "dado" ivory finish



PLAN15
SC-2-PAN

doppia porta scorrevole
 a scomparsa con ante
 in alluminio/vetro per
 cassonetti senza stipite
vetro stratificato nero
alluminio nero
maniglia "lingotto" nera

*double sliding aluminum/glass
 door for unframed pocket system*
glass laminated black
aluminium black finish
handle "lingotto" black finish

PLAN15
SC-1

porta scorrevole a scomparsa con ante
 in alluminio/vetro e stipite in alluminio
vetro temprato satinato bianco
alluminio bianco avorio
maniglia "dado" bianco avorio

*sliding aluminum/glass door for pocket
 system with aluminum frame*
glass tempered satin white
aluminium ivory finish
handle "dado" ivory finish

PLAN15
SC-2/P

porta scorrevole a scomparsa a due ante
 parallele in alluminio/vetro e stipite
 in alluminio
vetro temprato satinato bianco
alluminio bianco avorio
maniglia "dado" bianco avorio

*double telescopic sliding aluminum/glass
 doors for pocket system with
 aluminum frame*
glass tempered satin white
aluminium ivory finish
handle "dado" ivory finish



maniglia "cetra" e "dado con serratura" argento lucido
handle "cetra" and "dado with lock" polished silver finish

PLAN15 BL

porta a bilico con ante in alluminio/vetro senza stipite **vetro** temprato grigio trasparente **alluminio** argento opaco **maniglia** "olivari planet Q" cromo opaco con chiusura magnetica su adattatore orizzontale.

*pivot aluminum/glass door with aluminum frame **glass** tempered clear grey **aluminium** matt silver finish **handle** "olivari planet Q" and horizontal adaptor with magnetic lock, matt chrome finish*

PLAN LIBRO-2

porta a libro con ante in alluminio/vetro e stipite in alluminio **vetro** stratificato opalino **alluminio** argento lucido **maniglia** "cetra" e "dado con serratura" argento lucido

*folding aluminum/glass doors with aluminum frame **glass** laminated opal **aluminium** polished silver finish **handle** "cetra" and "dado with lock" polished silver finish*

cerniera superiore
upper hingecerniera superiore
upper hinge**PLAN BT-1-WMIX-PAN**

porta a battente con anta in alluminio/vetro e stipite in legno
vetro temprato satinato bronzo
alluminio nichel
maniglia "olivari tecno" nichel con serratura magnetica su adattatore rettangolare nichel
stipite in legno impiallacciato rovere tinto wengé

hinged aluminum/glass door with wood frame
glass tempered satin bronze
aluminium nikel finish
handle "olivari Tecno" and rectangular adaptor with magnetic lock, nickel finish
frame veneer wengé oak wood

PLAN BT-1-WMIX-AL

porta a battente con anta in legno e stipite in alluminio
anta in legno impiallacciato rovere sbiancato
stipite alluminio nichel
maniglia "olivari planet Q" nichel con serratura magnetica

hinged wood door with aluminium frame
door veneer bleached oak wood
aluminium frame nickel finish
handle "olivari planet Q" with magnetic lock, nickel finish



PORTA A BATTENTE
HINGED DOOR

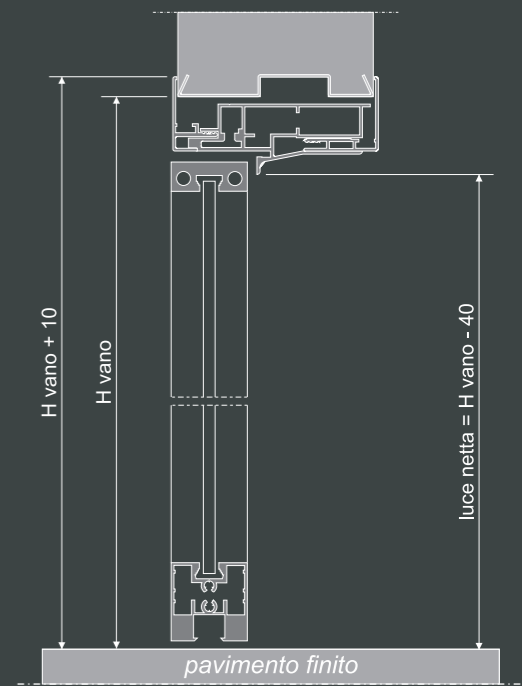
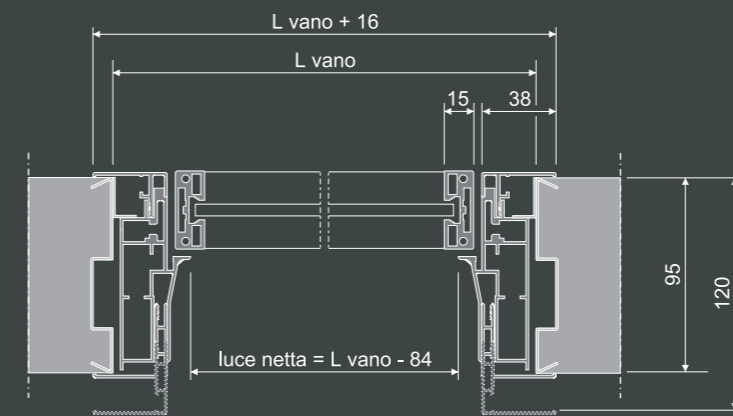

PORTA SCORREVOLE A SCOMPARS
SLIDING DOOR FOR POCKET SYSTEM

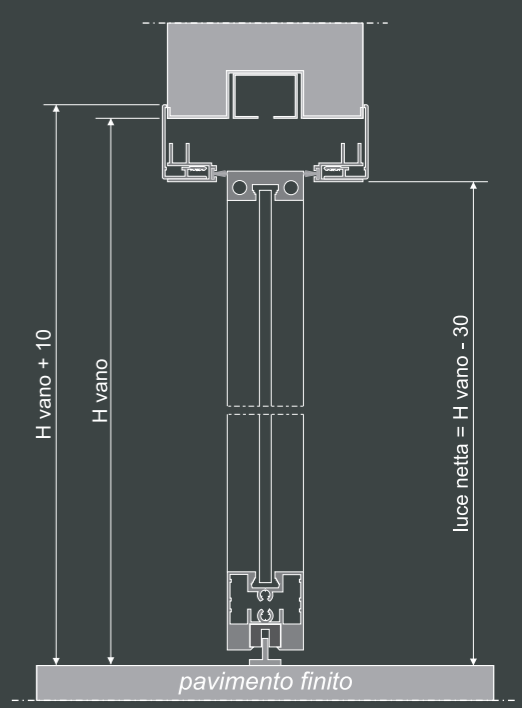
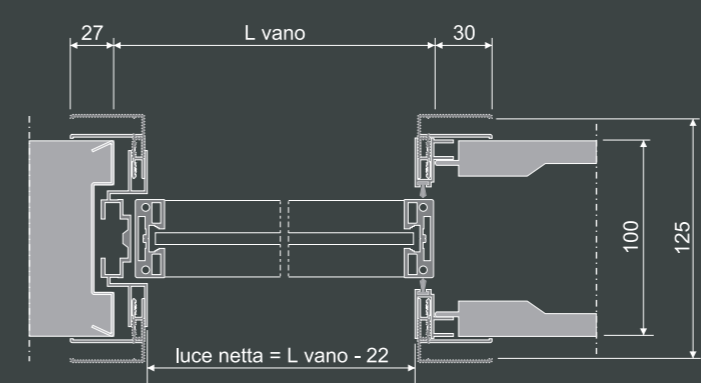



maniglia "olivari total" biocromo satinato con chiusura magnetica su adattatore orizzontale
handle "olivari total" biochrome satin finish and horizontal adaptor with magnetic lock, black finish



maniglia "olivari total" biocromo satinato con serratura magnetica su adattatore rettangolare
handle "olivari total" biochrome satin finish and rectangular adaptor with magnetic lock, black finish



SLIM BT-1

porta a battente con anta alluminio/vetro e stipite in alluminio
vetro temprato satinato bianco
alluminio nero
maniglia "olivari total" biocromo satinato con chiusura magnetica su adattatore orizzontale nero

*hinged aluminum/glass door with aluminum frame
glass tempered satin white
aluminium black finish
handle "olivari total" biochrome satin finish and horizontal adaptor with magnetic lock, black finish*



**SLIM
FS-COR-4**

pannello fisso in alluminio/vetro
e stipite in alluminio su 4 lati
vetro temprato trasparente
alluminio argento opaco

*fixed aluminum/glass panel
with 4 sides aluminum frame
glass tempered clear
aluminium matt silver finish*



maniglia "HEWI-serie 120"
bianca con serratura magnetica
su adattatore rettangolare bianco
handle iHEWI-serie 120i and
rectangular adaptor with
magnetic lock, white finish

**SLIM
BT-1**

porta a battente con anta alluminio/vetro
e stipite in alluminio
vetro stratificato bianco
alluminio bianco
maniglia "HEWI-serie 120" bianca
con serratura magnetica
su adattatore rettangolare bianco

*hinged aluminum/glass door
with aluminum frame
glass laminated white
aluminium white finish
handle "HEWI-serie 120" and
rectangular adaptor with
magnetic lock, white finish*

maniglia "olivari total" biocromo
satinato con serratura
magnetica su adattatore
rettangolare argento opaco

handle "olivari total" biochrome
satin finish and rectangular
adaptor with magnetic lock,
matt silver finish

**SLIM
BT-1**

porta a battente con anta alluminio/vetro e stipite in alluminio
vetro temprato trasparente
alluminio argento opaco
maniglia "olivari total" biocromo satinato con serratura
magnetica su adattatore rettangolare argento opaco

*hinged aluminum/glass door with aluminum frame
glass tempered clear
aluminium matt silver finish*

handle "olivari total" biochrome satin finish and rectangular
adaptor with magnetic lock, matt silver finish



maniglia "lingotto" argento opaco
handle "lingotto" matt silver finish



maniglia "lingotto con serratura" argento opaco
handle "lingotto with lock" matt silver finish

SLIM SC-1

porta scorrevole a scomparsa con anta in alluminio/vetro e stipite in alluminio
vetro temprato satinato bianco
alluminio argento opaco
maniglia "lingotto" e "lingotto con serratura" argento opaco

sliding aluminum/glass door for pocket system with aluminum frame
glass tempered satin white
aluminium matt silver finish
handle "lingotto" and "lingotto with lock" matt silver finish





maniglia "dado" nera
handle "dado" black finish



SLIM
SC-1

porta scorrevole a scomparsa
con anta in alluminio/vetro
e stipite in alluminio
vetro temprato grigio trasparente
alluminio nero
maniglia "lingotto" nera

*sliding aluminum/glass door
for pocket system with
aluminum frame
glass tempered clear grey
aluminium black finish
handle "lingotto" black finish*

SLIM
SC-1

porta scorrevole a scomparsa
con anta in alluminio/vetro e
stipite in alluminio
vetro temprato grigio trasparente
alluminio nero
maniglia "dado" nera

*sliding aluminum/glass
door for pocket system
with aluminum frame
glass tempered clear grey
aluminium black finish
handle "dado" black finish*



maniglia "ala" e "ala con serratura"
argento opaco
handle "ala" and "ala with lock" mat
silver finish



SLIM LIBRO-2

porta a libro con ante in alluminio/vetro
e stipite in alluminio
vetro temprato satinato bianco
alluminio argento opaco
maniglia "ala" e "ala con serratura"
argento opaco

*folding aluminum/glass doors
with aluminum frame
glass tempered satin white
aluminium matt silver finish
handle "ala" and "ala with lock"
matt silver finish*

SLIM BT-1-WMIX-AL

porta a battente con anta in
legno e stipite in alluminio
anta in legno laccata bianco lucido
stipite alluminio nichel
maniglia "olivari planet Q"
nichel con serratura magnetica

*hinged wood door with
aluminium frame
door gloss white lacquered wood
aluminium frame nikel finish
handle olivari planet Qi with
magnetic lock, nikel finish*



PORTA A BATTENTE
HINGED DOOR

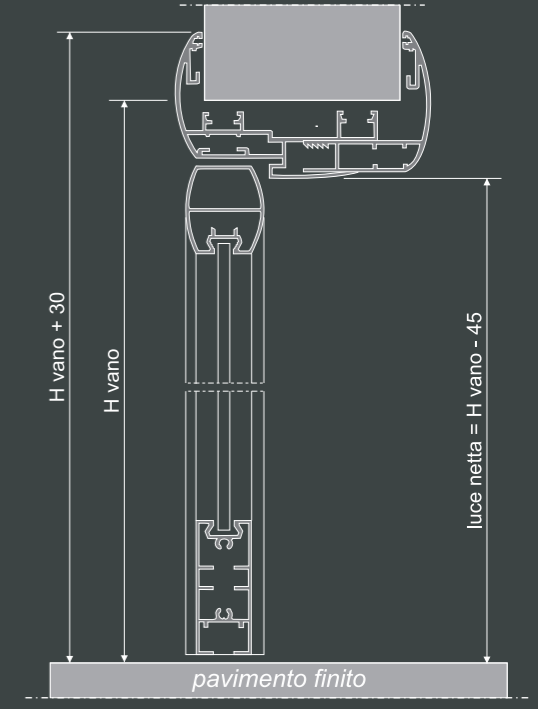
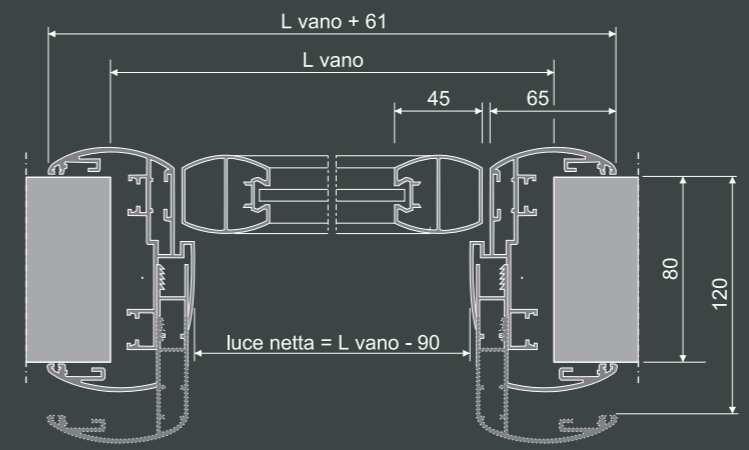

PORTA SCORREVOLE A SCOMPARSA
SLIDING DOOR FOR POCKET SYSTEM

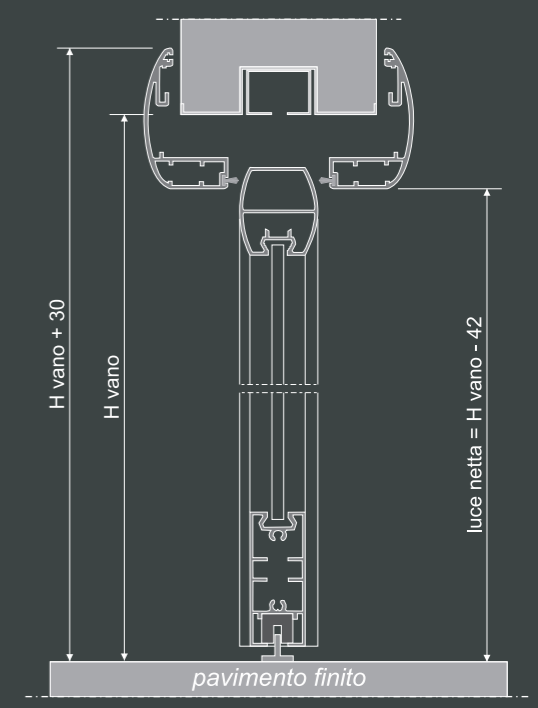
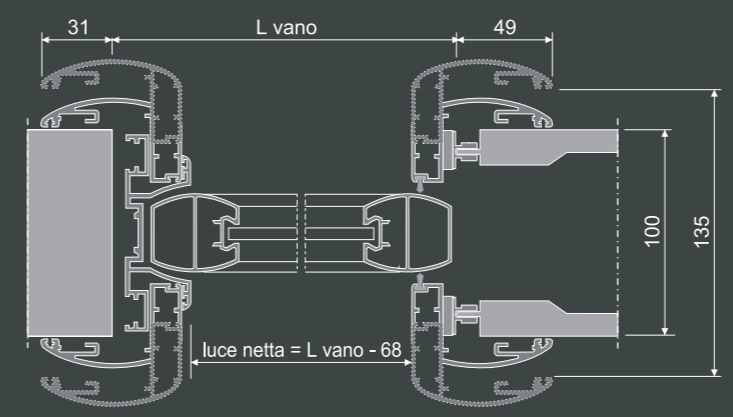



**SOFT
E/SF/NC**

quattro pannelli scorrevoli in alluminio/vetro
a soffitto con veletta in vista
vetro stratificato opalino
alluminio argento opaco
maniglia "flauto" argento opaco

*four sliding aluminum/glass doors ceiling
mounted with fascia
glass laminated opal
aluminium matt silver finish
handle "flauto" matt silver finish*

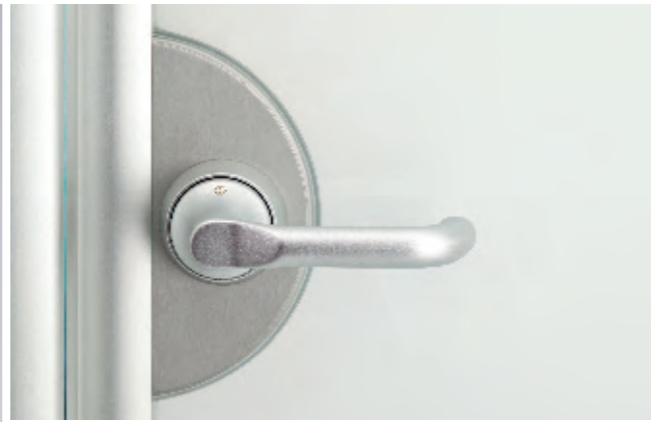

maniglia "HCS A138" argento opaco su adattatore HCS argento opaco
handle "HCS A138" and HCS adaptor matt silver finish



maniglia "olivari aurelia" cromo opaco con serratura magnetica su adattatore trapezoidale argento opaco
handle "olivari aurelia" mat chrome finish and trapezoidal adaptor with magnetic lock, matt silver finish



**SOFT
BT-1**

porta a battente con anta alluminio/vetro e stipite in alluminio
vetro temprato satinato bianco
alluminio argento opaco
maniglia "HCS A138" argento opaco su adattatore HCS argento opaco

hinged aluminum/glass door with aluminum frame
glass tempered satin white
aluminium matt silver finish
handle "HCS A138" and HCS adaptor matt silver finish

**SOFT
SC-1**

porta scorrevole a scomparsa con anta in alluminio/vetro e stipite in alluminio
vetro temprato satinato bianco
alluminio argento opaco
maniglia "arco" argento opaco

sliding aluminum/glass door for pocket system with aluminum frame
glass tempered satin white
aluminium matt silver finish
handle "arco" matt silver finish



**SOFT
LIBRO-2**

porta a libro con ante in alluminio/vetro e stipite in alluminio
vetro stratificato blu notte
alluminio argento opaco
maniglia "armonica" argento opaco

*folding aluminum/glass doors with aluminum frame
 glass laminated blue night
 aluminium matt silver finish
 handle "armonica" matt silver finish*



**SOFT
BT-1-WMIX-AL**

porta a battente con anta in legno e stipite in alluminio
anta in legno impiallacciato rovere wengé
stipite alluminio argento opaco
maniglia "olivari aurelia" cromo opaco con serratura magnetica

*hinged wood door with aluminium frame
 door veneer wengé oak wood
 aluminium frame matt silver finish
 handle "olivari aurelia" with magnetic lock matt chrome finish*



**SOFT
BT-1-WMIX-PAN**

porta a battente con anta in alluminio/vetro e stipite in legno
vetro stratificato opalino
alluminio argento opaco
maniglia "HCS A138/SK" argento opaco su adattatore HCS argento opaco
stipite in legno impiallacciato rovere tinto wengé

*hinged aluminum/glass door with wood frame
 glass laminated opal
 aluminium matt silver finish
 handle "HCS A138/SK" and HCS adaptor matt silver finish
 frame veneer wengé oak wood*

maniglie per ante in ALLUMINIO/VETRO PLAN-15, PLAN-40, SLIM : pannelli scorrevoli - porte scorrevoli a scomparsa - porte a libro
 ALUMINIUM/GLASS doors handles PLAN-15, PLAN-40, SLIM : sliding doors - sliding doors for pocket system - folding doors



dado



dado con serratura
 dado with lock



lingotto con serratura
 lingotto with lock

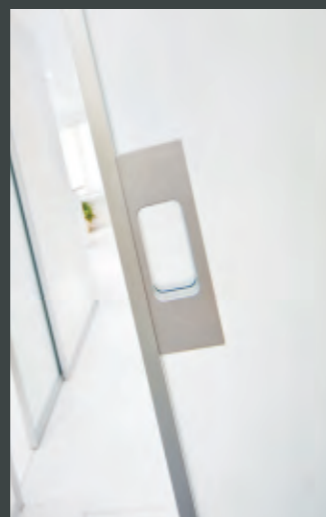

lingotto



ala

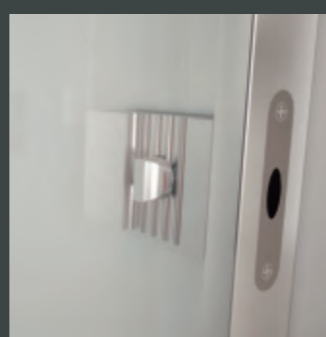

ala con serratura
 ala with lock

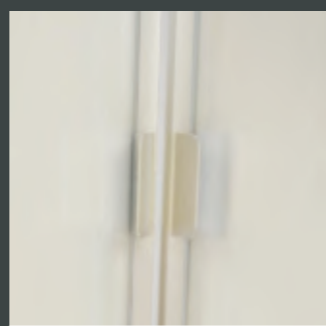

cetra

clip

maniglie hoppe HCS per PORTE A BATTENTE
 hoppe HCS HINGED DOORS handles



hoppe HCS 1880



hoppe HCS A197



hoppe HCS A138

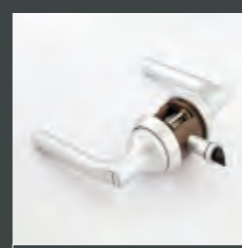

SK nottolino/bottone
 latch/button

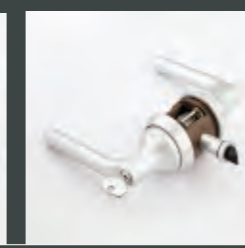

15 nottolino/chiave
 latch/key



15/15 chiave/chiave
 key/key

combinazioni di chiusura applicabili su tutte le maniglie hoppe HCS
 combination lock for hoppe HCS handles

maniglie tradizionali per PORTE A BATTENTE
 traditional HINGED DOORS handles



hewi-serie 120



olivari total



olivari planet Q



olivari tecno



olivari aurelia



reguitti q-arte

maniglie per ante in ALLUMINIO/VETRO SOFT : pannelli scorrevoli - porte scorrevoli a scomparsa - porte a libro
 ALUMINIUM/GLASS doors handles SOFT : sliding doors - sliding doors for pocket system - folding doors



flauto



arco



arpa



arpa con serratura
 arpa with lock



armonica

plan

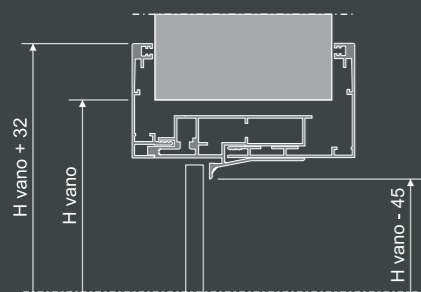
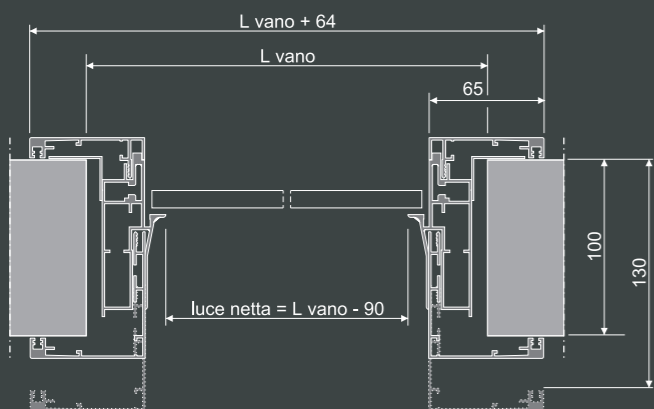

slim

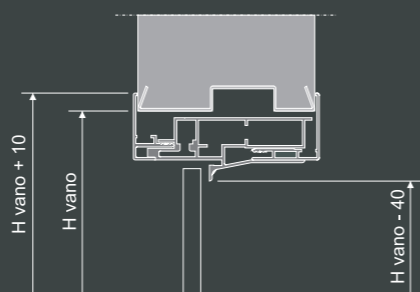
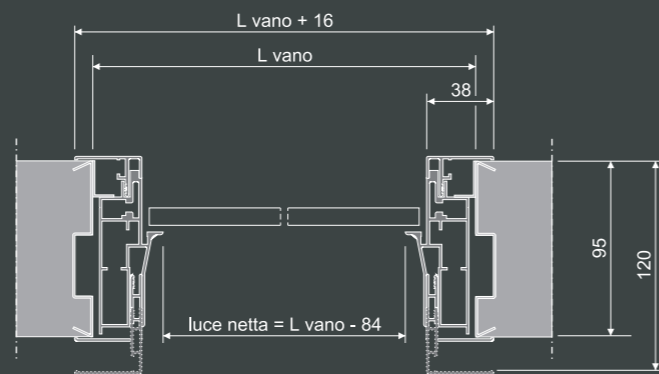

soft

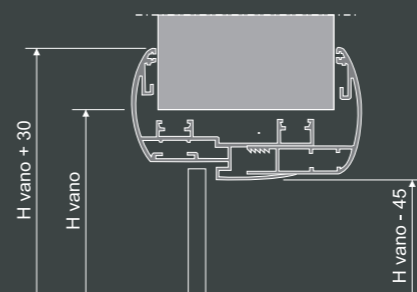
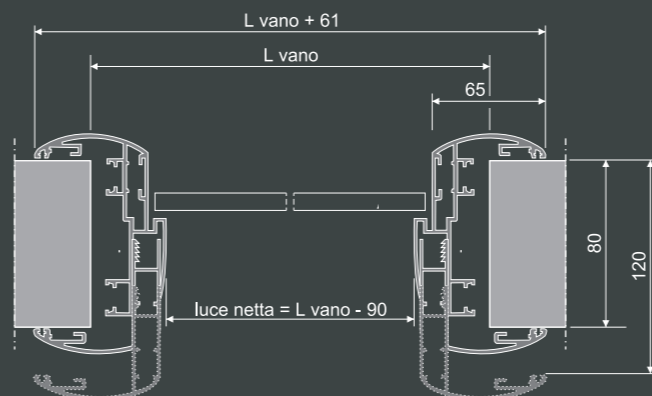

PORTA A BATTENTE - HINGED DOOR

PORTA SCORREVOLE A SCOMPARSA
SLIDING DOOR FOR POCKET SYSTEM

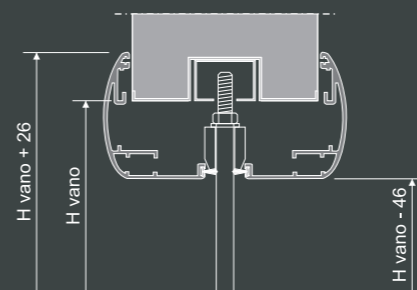
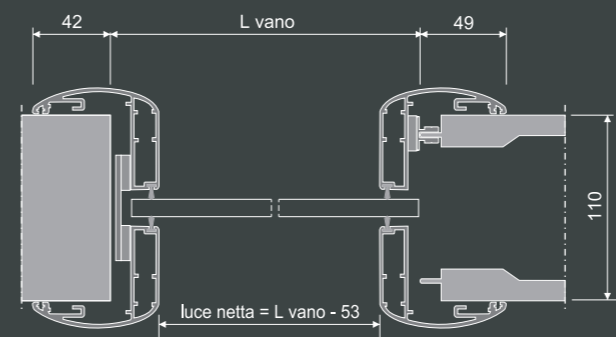
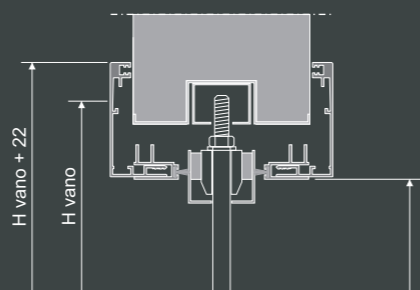
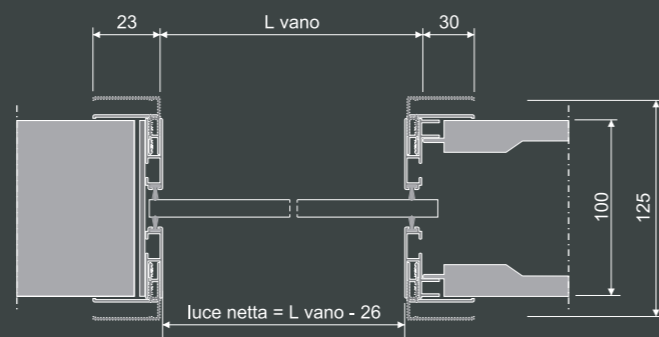
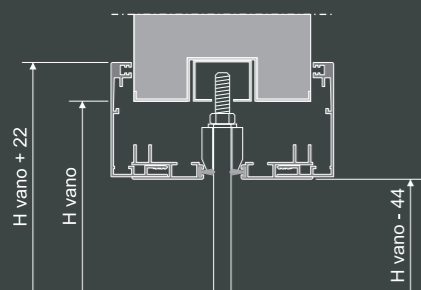
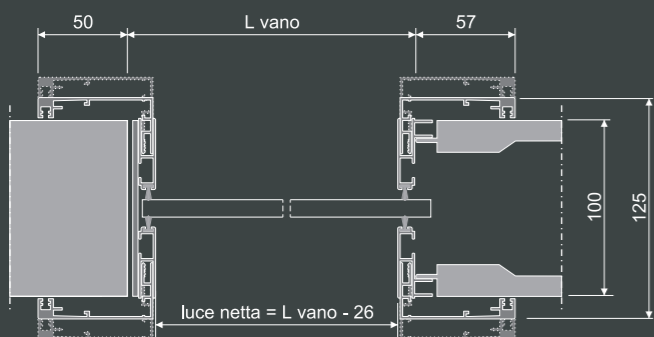



INOX SLIDE B/PT

doppio pannello scorrevole in vetro con binario
e accessori di scorrimento in vista a parete
vetro 10 mm. temprato satinato bronzo
sistema di scorrimento acciaio inox
maniglia "stilo 1200" acciaio inox

*double sliding frameless glass doors with stainless
steel bar and hangers
glass 10 mm. thick, tempered satin bronze
sliding system stainless steel
handle "stilo 1200" stainless steel*



sistema di scorrimento acciaio inox
sliding system stainless steel

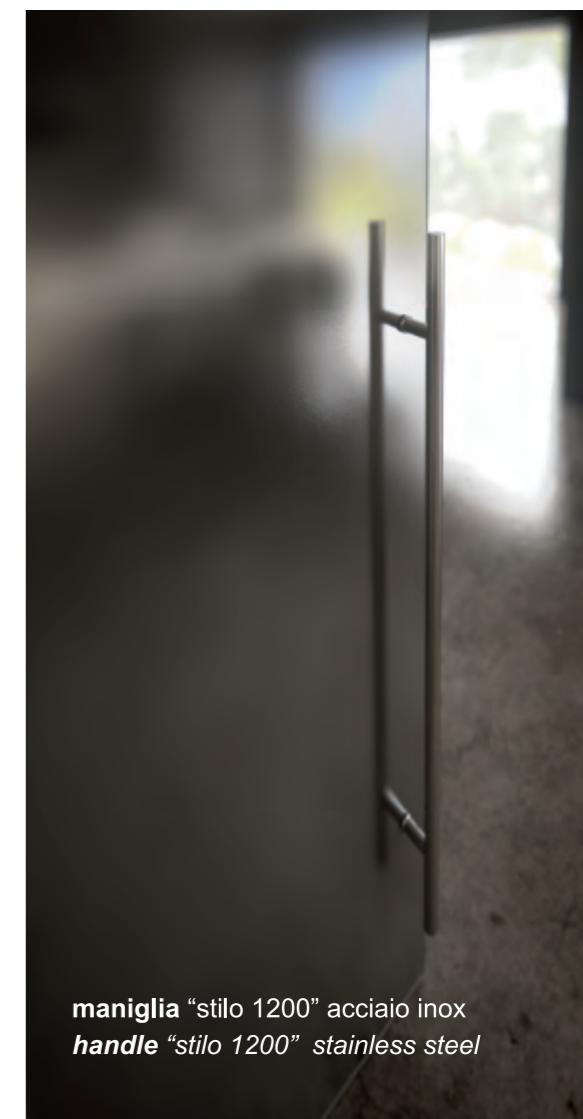

maniglia "stilo 1200" acciaio inox
handle "stilo 1200" stainless steel



SLACK E/SF/NC

due pannelli scorrevoli e due fissi
in vetro a soffitto con veletta in vista
vetro 10 mm. temprato trasparente
sistema di scorrimento argento
opaco h 103 mm.
maniglia "bridge 400" argento opaco

*double sliding frameless glass doors
and two fixed frameless glass panels
with ceiling attachment and fascia
glass 10 mm. thick, tempered clear
sliding system matt silver finish –
h 103 mm.
handle "bridge 400" matt silver finish*

FLO B/PT

doppio pannello scorrevole in vetro con veletta
in vista a parete
vetro 10 mm. temprato trasparente
sistema di scorrimento argento opaco – h 55 mm.
maniglia "5BN0" argento opaco

*double sliding frameless glass doors with wall
mounted track and fascia
glass 10 mm. thick, tempered clear
sliding system matt silver finish – h 55 mm.
handle "5BN0" matt silver finish*

maniglia "5BN0" argento opaco
handle "5BN0" matt silver finish

FLO A/PT

un pannello scorrevole in vetro con veletta
in vista a parete
vetro 10 mm. temprato trasparente
sistema di scorrimento argento opaco – h 55 mm.
Maniglia "5BN0" argento opaco

*single sliding frameless glass doors with
wall mounted track and fascia
glass 10 mm. thick, tempered clear
sliding system matt silver finish – h 55 mm.
handle "5BN0" matt silver finish*



FOLDING DIV-FAST-LIB6

divisorio pieghevole in vetro
vetro 10 mm. temprato satinato bianco
maniglia "B94 con nottolino di chiusura"
 argento opaco

folding sliding glass door divider
glass 10 mm. thick, tempered satin white
handle "B94 with locking latch" matt
 silver finish



cerniere "8665" argento
hinge "8665" silver finish



*hinged frameless glass door
with aluminum frame*
glass 10 mm. thick tempered satin white
aluminium matt silver finish
handle "HCS A197" matt silver
finish and HCS adaptor 6730,
matt silver finish
hinge "8665" silver finish



PLAN BT-1-EASY

porta a battente con anta in vetro
a muro senza stipite
vetro 10 mm. temprato satinato bianco
maniglia "bridge 200" argento opaco
cerniere "8630" argento con apertura
automatica 0°+90°-90°

*hinged frameless glass door
without frame*
glass 10 mm. thick tempered satin white
handle "bridge 200" matt silver finish
hinge "8630" silver finish with automatic
opening 0°+90°-90°

PLAN BT-1-FAST

porta a battente con anta in vetro e
stipite in alluminio
vetro 10 mm. temprato satinato bianco
alluminio argento opaco
maniglia "HCS A197" argento opaco
su adattatore 6730 argento
cerniere "8665" argento



cerniere "triloba" nera
hinge "triloba" black finish



cerniere "flexa" nera
hinge "flexa" black finish



maniglia "flexa" su adattatore "flexa" nero
handle "flexa" and "flexa adaptor" black finish



SLIM BT-1-FAST

porta a battente con anta in vetro e stipite in alluminio
vetro 5+5 mm. temprato e stratificato nero
alluminio nero
maniglia "flexa" su adattatore "flexa" nero
cerniere "flexa" nera

hinged frameless glass door with aluminum frame
glass 5+5 mm. thick tempered and laminated black
aluminium black finish
handle "flexa" and "flexa adaptor" black finish
hinge "flexa" black finish



maniglione "stilo 500" acciaio inox
handle "stilo 500" stainless steel

SLIM**BT-2-FAST-180 ∞**

porta a doppio battente con ante in vetro e stipite in alluminio
vetro 10 mm. temprato sabbizzato monofacciale con decoro personalizzato trasparente
alluminio argento opaco
maniglia "stilo 500" acciaio inox
cerniere "8630" apertura automatica 0°+90°-90° argento

double hinged frameless glass door with aluminum frame
glass 10 mm. thick tempered sanblasted on one side with clear custom decor
aluminium matt silver finish
handle "stilo 500" stainless steel
hinge "8630" automatic opening 0°+90°-90° silver finish

SLIM**BT-1-FAST-180 ∞**

porta a battente con anta in vetro e stipite in alluminio
vetro 10 mm. temprato satinato bianco
alluminio argento opaco
maniglione "stilo 500" acciaio inox
cerniere "8630" apertura automatica 0°+90°-90° argento

hinged frameless glass door with aluminum frame
glass 10 mm. thick tempered satin white
aluminium matt silver finish
handle "stilo 500" stainless steel
hinge "8630" automatic opening 0°+90°-90° silver finish



SOFT BT-1-FAST

porta a battente con anta in vetro e stipite in alluminio

vetro 10 mm. temprato e stratificato arancio

alluminio argento opaco

maniglia "HCS A138" argento opaco su

adattatore 6731 argento

cerniere "8664" argento

hinged frameless glass door with aluminum frame

glass 10 mm. thick tempered and laminated

orange

aluminium matt silver finish

handle "HCS A138" matt silver finish and HCS

adaptor 6731, silver finish

hinge "8664" silver finish



PLAN SC-2-FAST

doppia porta scorrevole a scomparsa con ante in vetro e stipite in alluminio
vetro 10 mm. temprato trasparente con disegno "la fascia" sabbiato monofacciale
alluminio nichel
maniglia "bridge 400" nichel

double sliding frameless glass doors for pocket system with aluminum frame
glass 10 mm. thick tempered clear with sandblasted on one side decoration "la fascia"
aluminium nikel finish
handle "bridge 400" nickel finish

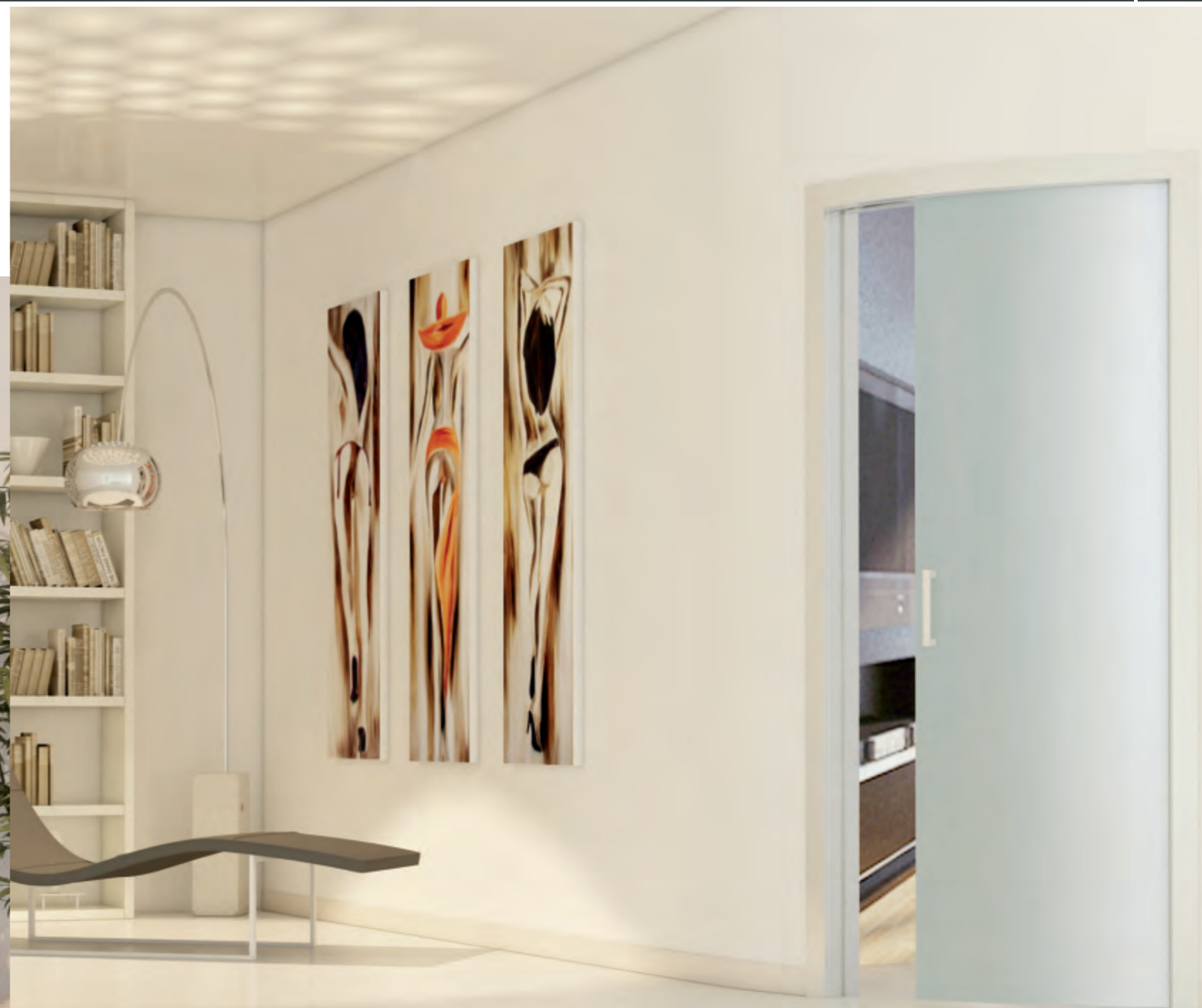

PLAN SC-1-FAST-CIRCULAR

porta scorrevole a scomparsa curva con ante in vetro e stipite in alluminio
vetro 10 mm. temprato satinato bianco
alluminio argento opaco
maniglia "bridge 200" argento opaco

circular sliding glass door for pocket system with aluminum frame
glass 10 mm. thick, tempered satin white
aluminium matt silver finish
handle "bridge 200" matt silver finish



SLIM SC-1-FAST

porta scorrevole a scomparsa con anta in vetro e stipite in alluminio
vetro 5+5 mm. temprato e stratificato satinato blu
alluminio argento opaco
maniglia "B93" argento opaco

*sliding frameless glass doors for pocket system with aluminum frame
glass 5+5 mm. thick tempered and laminated satin blue finish
aluminium matt silver finish
handle "B93" matt silver finish*



maniglia "jazz" cromo opaco
handle "jazz" matt chrome finish



SOFT SC-1-FAST

porta scorrevole a scomparsa con
 anta in vetro e stipite in alluminio
vetro 10 mm. temprato satinato bianco
alluminio argento opaco
maniglia "jazz" cromo opaco

*sliding frameless glass door for
 pocket system with aluminum frame
glass 10 mm. thick tempered satin white
aluminium matt silver finish
handle "jazz" matt chrome finish*



**PLAN
LIBRO-2-FAST**

porta a libro con ante in vetro e stipite in alluminio
vetro 10 mm. temprato satinato bianco
alluminio argento opaco
maniglia "B94 con nottolino di chiusura" argento opaco

*folding frameless glass door with aluminum frame
glass 10 mm. thick tempered satin white
aluminium matt silver finish
handle "B94 with locking latch" matt silver finish*



maniglia "B94 con nottolino di chiusura"
 argento opaco
handle "B94 with locking latch" matt
 silver finish



**SLIM
LIBRO-2-FAST**

porta a libro con ante in vetro e stipite
 in alluminio
vetro 10 mm. temprato satinato bianco
alluminio argento opaco
maniglia "B94 con nottolino di chiusura"
 argento opaco

*folding frameless glass door with
 aluminum frame
glass 10 mm. thick tempered satin white
aluminium matt silver finish
handle iB94 with locking latch
 matt silver finish*



SOFT LIBRO-2-FAST

porta a libro con ante in vetro e stipite in alluminio
vetro 10 mm. temprato satinato bianco
alluminio argento opaco
maniglia "B94 con nottolino di chiusura" argento opaco

folding frameless glass doors with aluminum frame
glass 10 mm. thick tempered satin white
aluminium matt silver finish
handle "B94 with locking latch" matt silver finish

maniglie per ante in VETRO FAST, EASY : pannelli scorrevoli - porte scorrevoli a scomparsa - porte a battente - porte a libro
 GLASS doors handles FAST, EASY : sliding doors - sliding doors for pocket system - hinged doors - folding doors

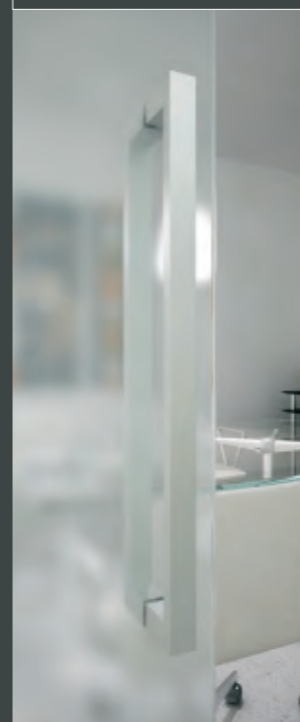

bridge 400

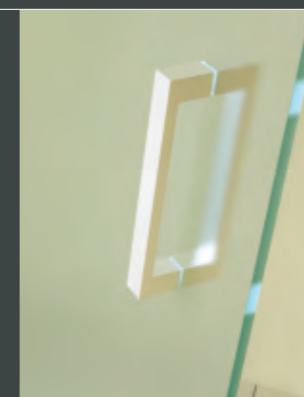

bridge 200



B94 con serratura
 B94 with lock



stilo 1200

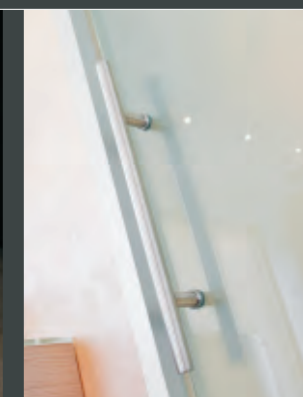

stilo 500



B93



5BN0

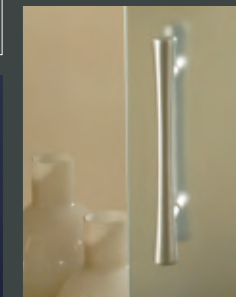

jazz



Realizzazione con porte d'arredo TEMA presso hotel
Hotel Pineta - MONSANO (AN)
Interior design - Andrea Sanchioni progetti

range of TEMA internal doors in hotel
Hotel Pineta - MONSANO (AN)
Interior design - Andrea Sanchioni progetti

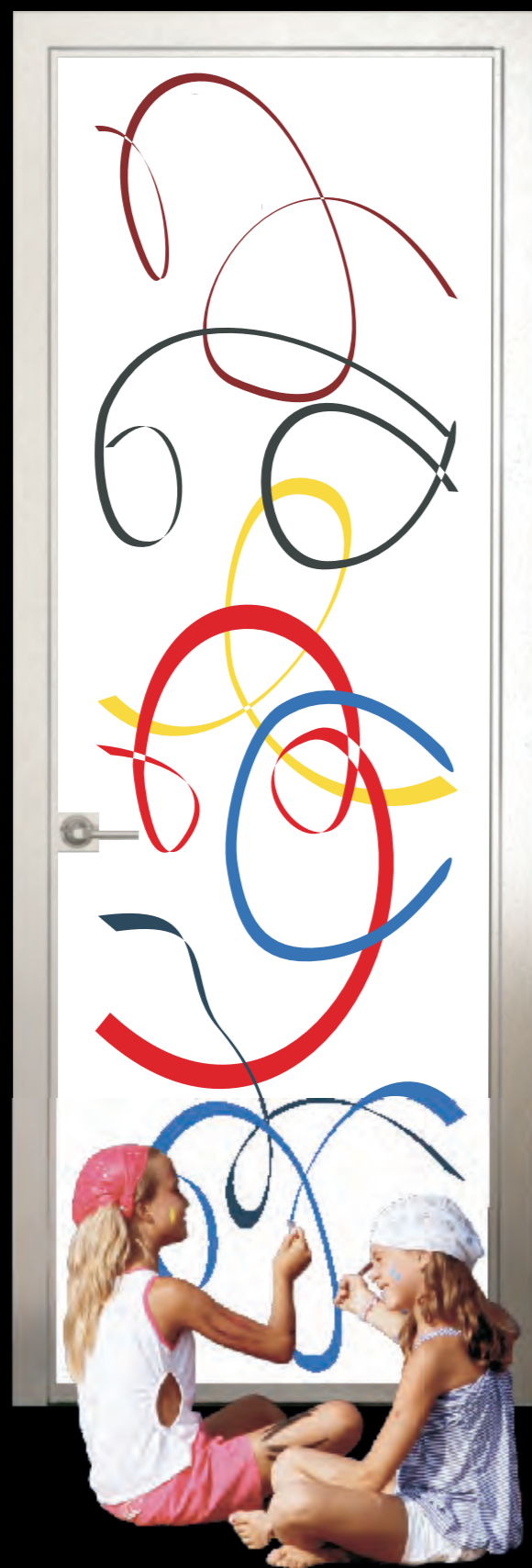

tema

P O R T E A P E R T E A L L A C R E A T I V I T À



foto scelta da te

Potete personalizzare la vostra porta richiedendo un vetro decorato con una vostra foto personale o scelta tra le tante immagini disponibili on-line. In questo secondo caso utilizzare immagini non coperte da diritti d'autore. In rete è possibile acquistare immagini a prezzi intorno ai 25 euro cad.; per esempio attraverso il sito www.istockphoto.com.

La qualità della decorazione dipende dalla definizione dell'immagine stessa che consigliamo almeno 2800-2900 x 4000-4100 pixel.

Consigliamo inoltre di spedire direttamente l'immagine su CD al nostro indirizzo :
TEMA s.r.l., Via Guazzi, sn. n° 61030
Tavernelle di Serrungarina (PU)

choose your own photo

You can customize your door with your own personal photo or you can choose from the many images available on-line, just make sure they are not copyrighted. On the web you can buy images at prices around 25 euros each; take a look at www.istockphoto.com for example.

*The quality of the decoration depends on the definition of the image that we recommend at least 2800 to 2900 x 4000 to 4100 pixels. Send your image directly to us on CD at our address:
TEMA s.r.l., Via Guazzi, sn. – 61030
Tavernelle di Serrungarina (PU)*



vetri opachi

external glass finishes

- 01. temprato satinato bianco
tempered satin white
- 02. temprato satinato bianco extrachiaro
tempered satin white extra clear
- 03. temprato satinato bronzo
tempered satin bronze
- 04. temprato satinato grigio
tempered satin grey
- 05. stratificato satinato bianco
laminated satin white
- 06. stratificato satinato nero
laminated satin black
- 07. stratificato satinato rosso
laminated satin red
- 08. stratificato satinato viola
laminated satin violet
- 09. stratificato satinato giallo
laminated satin yellow
- 10. stratificato satinato verde
laminated satin green
- 11. stratificato satinato verde chiaro
laminated satin light green
- 12. stratificato satinato blu
laminated satin blue
- 13. stratificato satinato fucsia
laminated satin fuchsia
- 14. stratificato satinato ambra
laminated satin amber



vetri lucidi

internal glass finishes

01. stratificato opalino
laminated opal
02. stratificato bianco
laminated white
03. stratificato bianco perla
laminated pearl white
04. stratificato nero
laminated black
05. stratificato marrone
laminated brown
06. stratificato beige
laminated beige
07. stratificato arancio
laminated orange
08. stratificato rosso
laminated red
09. stratificato verde
laminated green
10. stratificato rosa
laminated pink
11. stratificato fucsia
laminated fuchsia
12. stratificato argento
laminated silver
13. stratificato bordeaux
laminated bordeaux
14. stratificato violetto
laminated violet
15. stratificato blu notte
laminated blue night
16. stratificato grigio
laminated grey
17. stratificato giallo
laminated yellow
18. specchio bifacciale
double face mirror
19. temprato riflettente grigio
tempered reflecting grey
20. temprato riflettente bronzo
tempered reflecting bronze
21. temprato trasparente
tempered clear
22. temprato extrachiario trasparente
tempered extra clear
23. temprato grigio trasparente
Tempered clear grey
24. temprato bronzo trasparente
tempered clear bronze



vetro 5+5 mm. temprato e stratificato nero
 glass 5+5 mm. thick tempered and laminated black finish



la fascia

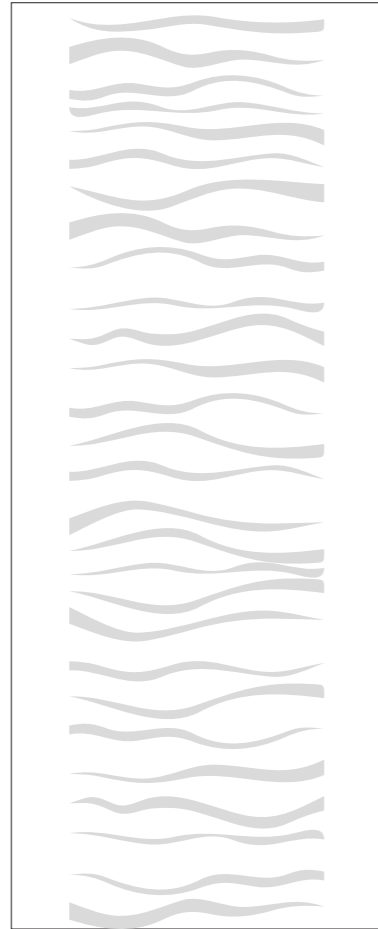

le onde

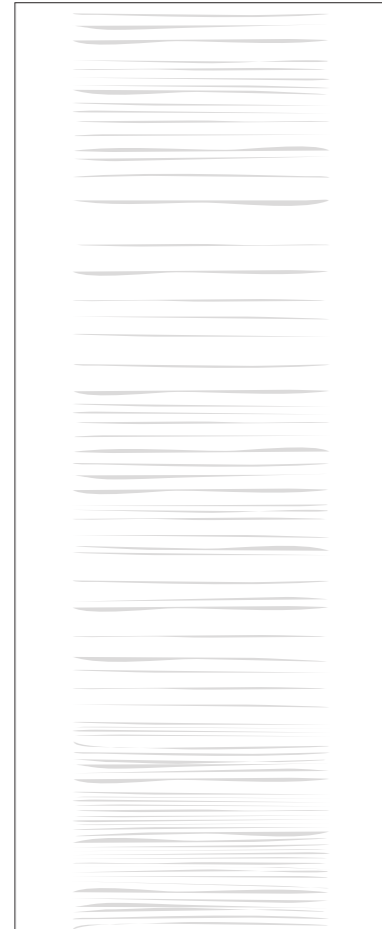

la tenda



l'orologio

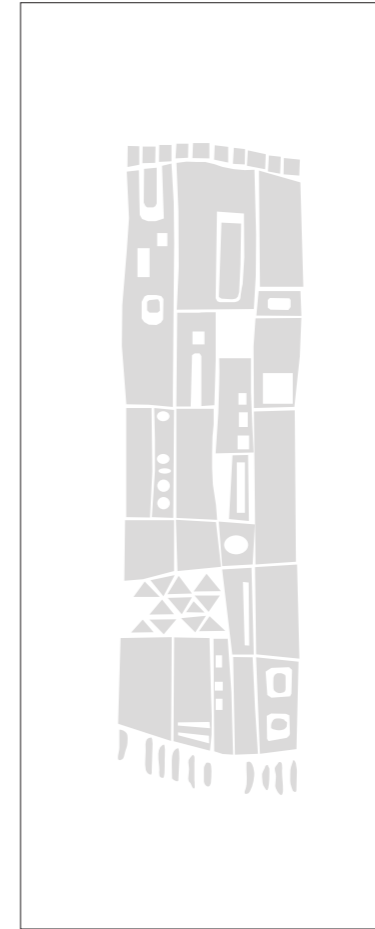

il tappeto



la foresta

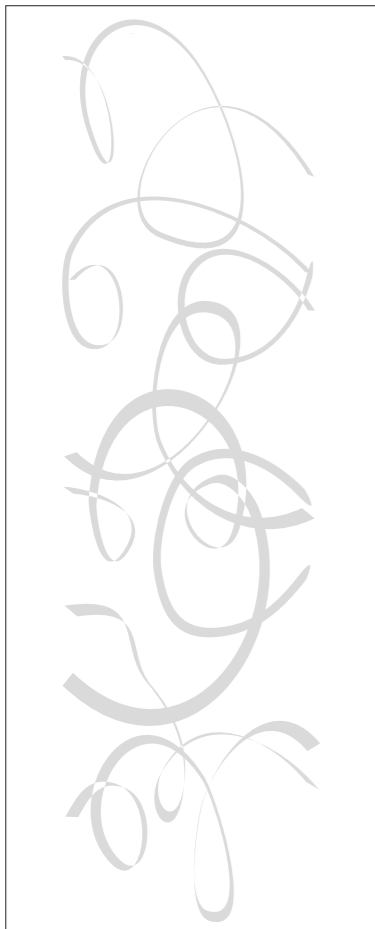

le curve



lo scarabocchio

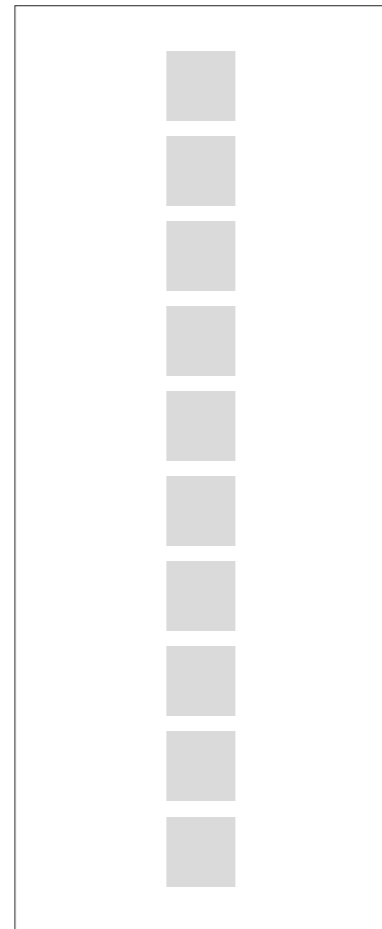

la colonna



l'albero 1



l'albero 2a

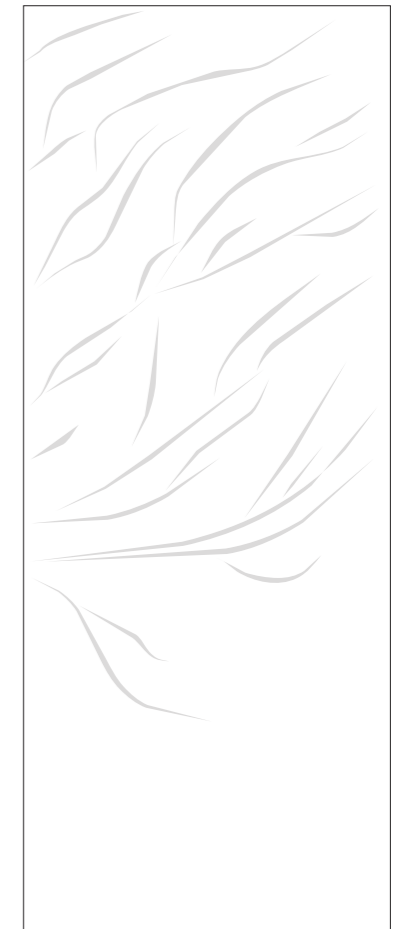

l'albero 2b

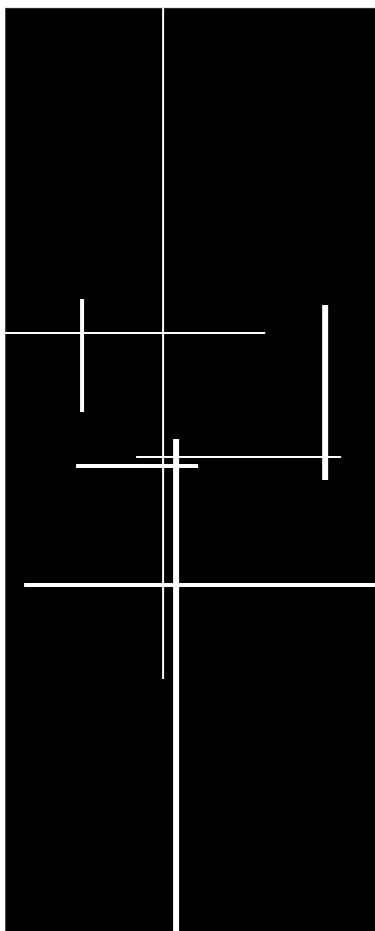

minimal 2 nero

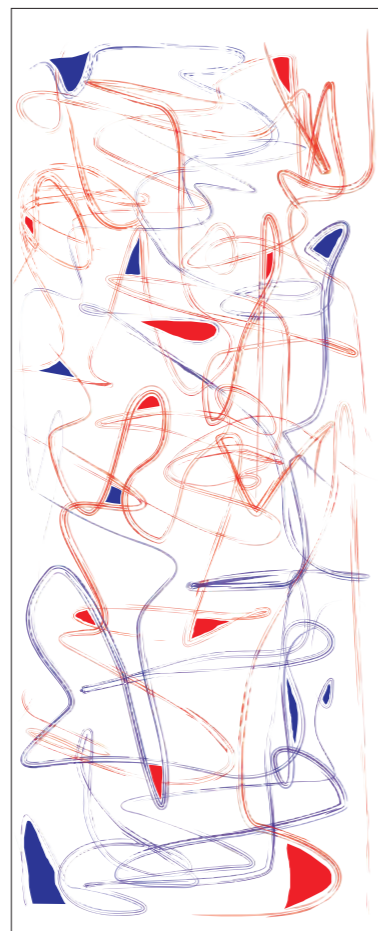

lo scarabocchio



Il bosco



la tristezza

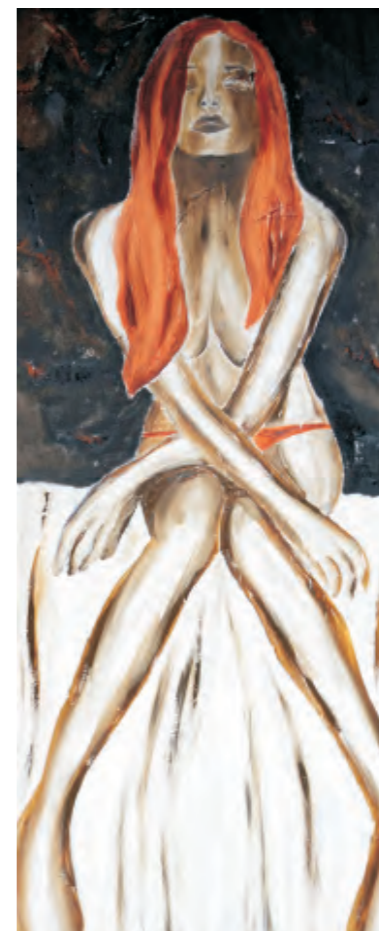

l'attesa



la fatica

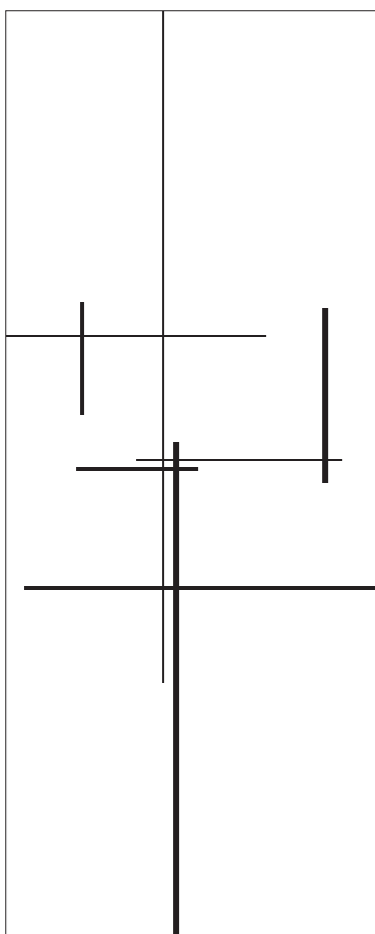

minimal 2 bianco

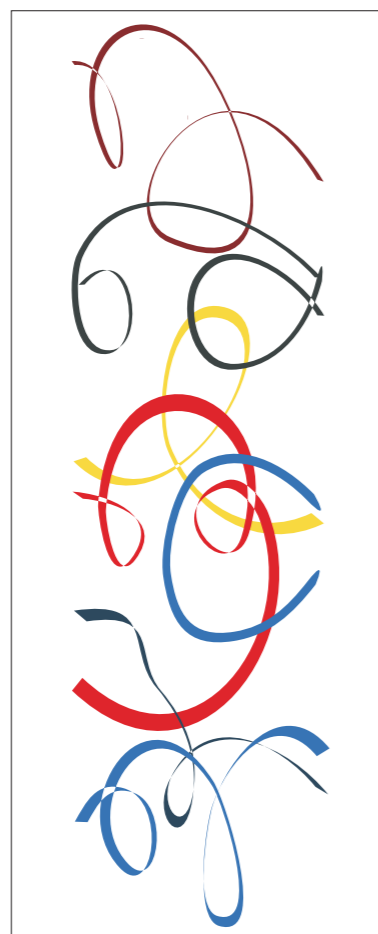

le curve



new york



geometria 2



dark roads



toro bianco



finiture alluminio

argento opaco - piombo - nero - testa di moro

Finiture opache ottenute per anodizzazione conforme alle norme EN 12373, ISO 2370. La struttura della porta viene inoltre trattata con specifici prodotti al fine di risaltare la brillantezza e la luminosità stessa del metallo.

argento lucido - nichel

Finiture lucide ottenute per ossidazione anodica previa spazzolatura a lucido della superficie.

tinto legno rovere sbiancato

L'effetto legno si ottiene attraverso uno specifico processo di sublimazione che consente di ottenere riproduzioni estremamente fedeli alle caratteristiche tipiche del legno. La lavorazione consiste di due fasi ben distinte: verniciatura di rivestimento superficiale e sublimazione del rivestimento nelle essenze di legno desiderato.

bianco - bianco avorio

Finiture laccate ottenute per verniciatura con vernici antigraffio epossidiche in polvere e polimerizzate a forno. Su richiesta è possibile avere una vasta gamma dei colori RAL.

aluminium finishes

matt silver – lead – black - dark brown

Matt anodized finishes conform to the EN 12373rd, ISO 2370 standards. The door frame is then specially treated to enhance the brilliance and brightness of the finish.

polished silver – nickel

the polished finish is obtained by anodizing a previously brush polished finish.

bleached oak

The surface is first painted and then a film of wood finish is applied to ensure a faithful reproduction of bleached oak.

white - ivory

Lacquer finishes obtained by scratch-resistant epoxy powder coating. A wide range of RAL colours are available on request.



Salvino Bellavia

direzione artistica

Salvino Bellavia

art direction

Marco Bargnesi

fotografia

Marco Bargnesi

photo

Marco Laschi

modellazione 3D

Marco Laschi

3D modeling

Ideostampa

stampa

Ideostampa

print

si ringraziano per la cortese collaborazione

abitazione privata **Angeli Roberto** - RICCIONE (RN)

negozio espositivo **casa Berloni** - FANO (PU)

Hotel Pineta - MONSANO (AN)

Studio Dentistico Dr. Bacchiocchi - CASTELFIDARDO (AN)

we thank for the kind cooperation

private residence of Angeli Roberto - RICCIONE (RN)

show room - ***casa Berloni*** - FANO (PU)

Hotel Pineta - MONSANO (AN)

Dental Surgery Dr. Bacchiocchi - CASTELFIDARDO (AN)

Le fotografie, i disegni, le illustrazioni, le finiture ed i colori di questo catalogo hanno valore indicativo. Tema s.r.l. declina ogni responsabilità per le possibili inesattezze contenute, dovute ad errori di stampa, di trascrizione o per qualsiasi altro motivo e si riserva il diritto di apportare modifiche, atte a migliorare i prodotti, senza preavviso. La riproduzione anche parziale è severamente vietata a norma di legge.

All Photographs, designs, illustrations, finishes and colours in this catalogue are indicative only. Tema s.r.l. are not responsible or liable for any errors, inaccuracies or omissions from the use of this information. Tema s.r.l. does not warrant the accuracy or completeness of the content, all information is provided "as is" without any conditions, warranties, representations or other terms of any kind. Tema s.r.l. reserves the right to modify/change the information without prior notice. All content is subject to copyright and whole or part reproduction of such is prohibited by law.

Tema s.r.l.

Via Guazzi - 61030 Tavernelle di Serrungarina (PU)
Tel. (+39)0721.892294 - Fax (+39)0721.878280

info@temadoors.it

www.temadoors.it